

OXFORD IB PREPARED



PHYSICS

ANSWERS



IB DIPLOMA PROGRAMME

David Homer

OXFORD

IB Prepared Physics

Answers to practice problems

Here are the answers to the practice problems from *IB Prepared Physics*.

For direct access, click on the name of the chapter.

[Topic 1 Measurements and uncertainties](#)

[Topic 2 Mechanics](#)

[Topic 3 Thermal physics](#)

[Topic 4 Oscillations and waves](#)

[Topic 5 Electricity and magnetism](#)

[Topic 6 Circular motion and gravity](#)

[Topic 7 Atomic, nuclear and particle physics](#)

[Topic 8 Energy production](#)

[Topic 9 Wave phenomena \(AHL\)](#)

[Topic 10 Fields \(AHL\)](#)

[Topic 11 Electromagnetic induction \(AHL\)](#)

[Topic 12 Quantum and nuclear physics \(AHL\)](#)

[13 Data-based and practical questions \(Section A\)](#)

[Option A Relativity](#)

[Option B Engineering physics](#)

[Option C Imaging](#)

[Option D Astrophysics](#)

1 Measurements and uncertainties

- a) $\text{kg m}^2 \text{s}^{-3}$, kg m s^{-2} , $\text{kg m}^{-1} \text{s}^{-2}$, $\text{kg s}^{-2} \text{A}^{-1}$ b) m s^{-2} , m s^{-2} , $\text{kg m s}^{-3} \text{A}^{-1}$, $\text{kg m}^2 \text{s}^{-2}$
- $1.68 \times 10^{-27} \text{ kg}$; $6.6 \times 10^{-34} \text{ J s}$; $1.6 \times 10^{-19} \text{ C}$; $1.2566 \times 10^{-6} \text{ T m A}^{-1}$
- a) 4.9×10^3 b) 5.19×10^{-3} c) 3.98×10 d) 9.28×10^6 e) 3.52×10^{-2}
- These are suggestions for ways to approach the estimates; other methods are possible.

 - Estimate the number of weeks or months and convert to days and multiply by 24×3600
 - Estimate volume, and hence number of atoms; one copper atom supplies one free electron
 - Estimate dimensions of a door of your choice
 - Estimate mass of egg, 1 mol is 18 g
 - Assume it is carbon with a molar mass of 12 g; estimate volume of liquid in pen and assume the density similar to that of water
 - Estimate time to fully discharge; look at AA cell for capacity
 - See a)
 - Estimate amount of tread worn during average life of tyre
- a) $(347 \pm 56) \text{ kJ}$ b) $(4.6 \pm 1.1) \times 10^{-2} \text{ N}$ c) $(115 \pm 12) \text{ mol}$
- 112 km on a bearing of 065°

2 Mechanics

- a) 108 m b) 6.32 s
- a) 15 m s^{-1} b) 90 m
- a) 2.85 kN
b) As speed increase drag increases; eventually magnitude of drag = magnitude of engine force but in opposite direction.

4. a)

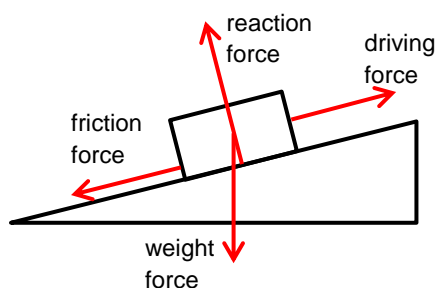

- b) 200 kW c) 0.65 m s^{-1} d) 2.8 kN
- i) 11.3 kN
ii) As bus slows so resistive force decreases and net force is reduced; this never falls below 8.9 kN (the weight component).

5. a) 11.3 kg m s^{-1} b) 110 N
6. The belt increases the time taken for the passenger/driver to stop moving; the change in momentum is the same for a given passenger mass and initial speed, so the force exerted on the passenger is smaller.

3 Thermal physics

1. a) $Q = mc\Delta T$ so as X has higher c it must have higher Q and greater internal energy.
 b) i) 0.066 kg s^{-1} ii) Energy transfers to the surroundings
2. a) Thermal: energy transferred in the form of heat; internal: energy of an ensemble of atoms that is the sum of their kinetic and potential energies.
 b) An ideal gas has no potential energy as the particles are assumed not to interact except during collisions; metal atoms possess potential energy.
3. a) The kinetic energy of the particles increases so their average speed increases; this means that the momentum change at wall increases and also that the time between wall collision decreases; this increases the force on the wall and therefore the pressure (as the volume is fixed).
 b) The kinetic energy and the average particle speed increase so the force at wall will increase; to keep the pressure constant the area of the walls must increase so the volume must also increase.
4. a) $5.9 \times 10^{-3} \text{ m}^3$ b) $1000 \text{ K (727 } ^\circ\text{C)}$
5. a) i) 0.078 mol ii) 0.0072 mol iii) $1.6 \times 10^5 \text{ Pa}$
 b) In kinetic model particles are moving; pressure is the rate of change of momentum per unit area at the container walls; there are more gas particles when air is pumped in, so there are more collisions at the walls per second and therefore a greater pressure
6. a) $6.2 \times 10^{-21} \text{ J}$ b) $2.4 \times 10^5 \text{ m}^2 \text{ s}^{-2}$
 c) The answers to a) and b) are means, so there must be values both above and below the average value

4 Oscillations and waves

1. a) $\frac{\pi}{2} \text{ rad}$ b) \sin^2 graph always positive; two cycles shown in time for one cycle of shm
2. B
3. Distance of travel of air molecule from its mean position parallel to direction of energy transfer; maximum displacement of air molecules; shortest distance between two air molecules moving in phase.
4. a), b) See Figures 4.2.1 and 4.2.2, page 37 in *IB Prepared Physics*.
 c) Two points $\frac{1}{4}$ cycle apart on a displacement–distance graph
5. 20 mm
6. 24 W m^{-2}

5 Electricity and magnetism

- a) 25.2 kC b) 300 kJ c) 300 m
- a) $7.0 \times 10^{12} \text{ m s}^{-2}$
 b) An electron is accelerated before colliding with positive ions in wire; energy is transferred away from the kinetic energy of the electron; the process repeats leading to a constant average speed.
- a) 0.20 A b) 0.12 A
- a) B – the graph is a straight line through the origin.
 b) i) 2.5 Ω ; 8.7 Ω
 ii) A higher current means a higher temperature for the filament; the increased temperature increases the vibrational motion of the positive ions so there is more interaction with electrons whose motion is impeded more; this is an increase in the resistance of the wire.
 c) $4.6 \times 10^{-7} \Omega \text{ m}$
- At XY the magnetic field due to PQ is into the page; the current in XY is within this field and therefore a force is exerted on it; Fleming's left-hand direction rule indicates that the force acting on XY is towards PQ.
- a) 0.83 mm s⁻¹ b) 62 kJ

6 Circular motion and gravity

- a) The force is towards centre of circle; arises at track to provide centripetal acceleration to train.
 b) 0.0051 N
- a) As both the gravitational and electric forces reduce by 4 \times there is no change.
 b) The gravitational force doubles so the electrostatic must double; the charge on Y doubles but retains same sign.
- The force acts at 90° to the velocity vector direction and provides the centripetal acceleration to keep the satellite at a constant orbital radius; there is no component of acceleration in the velocity direction so the speed does not change.
- a) $3.8 \times 10^{-23} \text{ kg m s}^{-1}$ b) $3.6 \times 10^{-14} \text{ N}$ c) Towards centre of circle

7 Atomic, nuclear and particle physics

1. a) Time taken for half the active nuclei to decay.

b)

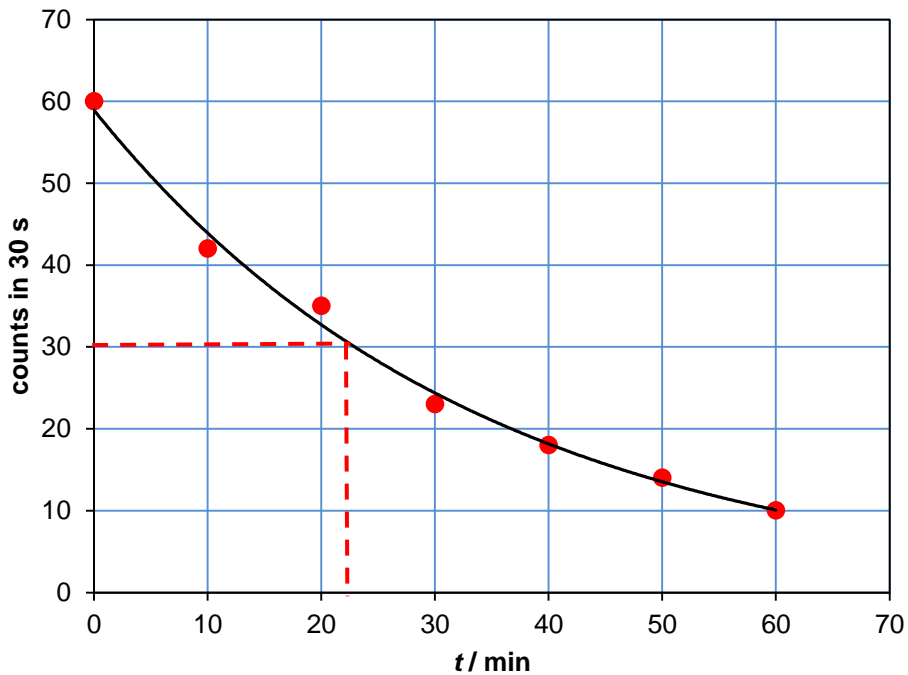

Approximately 22 minutes.

2. a) $2.1 \times 10^6 \text{ m s}^{-1}$

b) i) Yes, as energy difference is $1.9 \times 10^{-18} \text{ J}$

ii) $4.6 \times 10^{14} \text{ Hz} = 6.5 \times 10^{-7} \text{ m}$

iii) Visible light (650 nm)

3. a) ${}_{96}^{240}\text{Pu} \rightarrow {}_{92}^{236}\text{U} + 4 {}_2^4\alpha$

b) $1.2 \times 10^{-12} \text{ J}$

4. a) i) Fe-56 or Ni-58

ii) 8.8 meV per nucleon so 490 meV

b) i) positron

ii) electron neutrino

iii) LHS charge = $1 + 1 = 2$; RHS charge = 2

LHS baryon number = $1 + 1 = 2$; RHS baryon number = 2

LHS lepton number = 0; RHS lepton number = $-1 + 1 = 0$

5. a) uud b) $u\bar{d}$

6. a) Baryon number and strangeness are not conserved so this is not possible.

b) Possible because charge and baryon number are conserved.

8 Energy production

1. Arguments can include the following:

Nuclear	Coal-fired
High environmental cost after decommissioning	High environmental cost during use
Low transport costs	High transport costs as town isolated
Construction costs similar	Construction costs similar
Long decommissioning time	Quick to dismantle

2. a) 47 J
 b) Factors include: need to be uninterrupted and well-located supplies; water flows need to be appropriate; there are issues regarding transferring the energy to end-user; installation cost.
3. a) Decreases by 3.4 W m^{-2} b) eg: albedo depends on cloud cover etc.
4. a) A greenhouse gas is a gas that absorbs infra-red wavelengths leaving the Earth's surface, and re-emits them in all directions, which increases the incident radiation on the surface.
 b) 890 kg per year
5. a) 240 m^2
 b) To allow for instances when the incident intensity is not at its maximum value .
 c) No energy is transferred at night; energy transfer varies with season, for example.
6. a) $4.0 \times 10^{26} \text{ W}$ b) 5800 K

9 Wave phenomena (AHL)

1. a) 15.9 m b) i) 3.1 m s^{-2} ii) 4.6 kN
2. a) 0.24°
 b) The centre of pattern is white; there are colours away from centre depending on colour that is missing; red is diffracted more than blue.
3. a) i) 5.0 mrad i) 2.0 mrad b) 4.0 mm
4. a) Reflections occur from both the top surface and the interface between oil and water; destructive interference occurs at one wavelength between the reflected rays; this wavelength is removed from the white light leaving the resultant light coloured.
 b) The effective path difference increases as the eye moves from the normal case to the oblique case; the wavelength that is destructively removed changes, so the removed colour (and the appearance of the fringes) changes.
5. a) Two images are resolved if the first minimum of one is situated at central maximum of the other, or at a greater distance.
 b) $5.0 \times 10^{-4} \text{ rad}$
6. a) Diagram showing f as the frequency emitted by the source leading to a wavelength λ ; the observer crosses the wavefronts as they move towards each other, so f is the frequency at which the observer crosses the wavefronts.
 b) 314 Hz

10 Fields (AHL)

- a) Straight line from (0,0) to (0.02, 1500) on graph of potential / V (y-axis) against distance / m (x-axis)

b) Ball is accelerated with $a = 0.45 \text{ m s}^{-2}$ towards negative plate; strikes it at 9.0 mm s^{-1} ; will then transfer charge and begin to oscillate between plates.
- a) g is the force per unit mass that acts on small test mass.

b) $1.9 \times 10^{21} \text{ kg}$
- a) 220 m b) mass of He is $4m_p$ and charge is $2e$ so 440 m
- a) The work done in moving a unit positive charge from the point to infinity

b) i) 3.0 nC ii) $2.3 \times 10^{-17} \text{ N C}^{-1}$ iii) $2.3 \times 10^{-17} \text{ N C}^{-1}$
- a) The gravitational force provides the centripetal force, so there is acceleration towards the centre of planet; speed is unchanged but there is a change in velocity as the direction changes.

b)
$$v = \frac{2\pi \times 9.4 \times 10^6}{460 \times 60} = 2139 \text{ m s}^{-1} = 2 \text{ km s}^{-1} \text{ approximately}$$

c) $6.5 \times 10^{23} \text{ kg}$

11 Electromagnetic induction (AHL)

- a) Emf shown in blue.

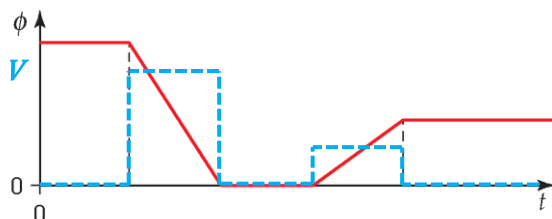

- b) Emf only non-zero when flux is changing, the larger the value of $\frac{d\phi}{dt}$ the larger the value of the magnitude of emf.
- 42 mA
- a) 1.2 mV b) vehicle must be moving at 90° to magnetic field
- a) Anticlockwise because emf in Y will oppose increase in field due to X.

b) Clockwise because emf in Y will try to prevent the collapse of the field due to X.
- a) Move plates closer, insert a dielectric

b) i) 0.22 M Ω

ii) see Figure 11.3.4, page 125 in *IB Prepared Physics*, with vertical axis changed to voltage / V

iii) Change R to 0.33 M
- a) 4.0 J b) 29 %

12 Quantum and nuclear physics (AHL)

1. a) The effect occurs instantaneously at all intensities; one photon carries enough energy for release without the need to wait for energy to accumulate, as in the wave model.
- b) i) The work function is the minimum energy required to emit an electron from the surface with zero kinetic energy.
 ii) $2.5 \times 10^{-19} \text{ J}$
2. a) $1.8 \times 10^{-11} \text{ m}$
- b) i) Pattern of concentric circles drawn.
 ii) The pattern resembles the diffraction pattern produced when light waves are incident on a circular aperture.
- c) Electrons are accelerated using a potential difference; this is particle-like behaviour as energy is transferred to the kinetic energy which is related to the electron's mass.
3. a) It is not possible to predict when a nucleus, or which nucleus, is going to decay next

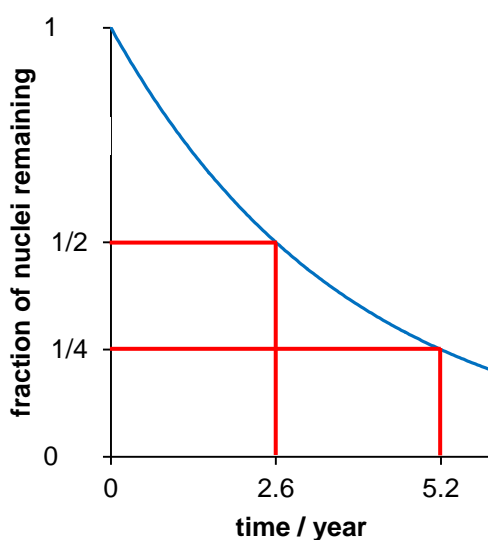

- c) i) $8.5 \times 10^{-9} \text{ s}^{-1}$ ii) $6.5 \times 10^{13} \text{ atoms}$ iii) $3.4 \times 10^7 \text{ s}$
4. a) The energy depends only on the energy of the incident photon; the intensity depends on the number of photons.
- b) Emission is caused by the transfer of all of the photon energy as soon as it arrives; the wave model would imply the need to wait for energy to build up and a one-to-one correspondence between the photon and the emitted electron.
- c) i) $1.1 \times 10^{-19} \text{ J}$ ii) $1.3 \times 10^{-15} \text{ A}$
5. a) ${}_{55}^{127}\text{Cs} \rightarrow {}_{56}^{127}\text{Ba} + {}_{-1}^0\text{e} + \bar{\nu}_e$ b) 0.98%
- c) Fission gives rise to two or more nuclear products; these will distort the fuel rods making it impossible to remove them from the reactor
6. a) $3.9 \times 10^{-15} \text{ m}$

b)

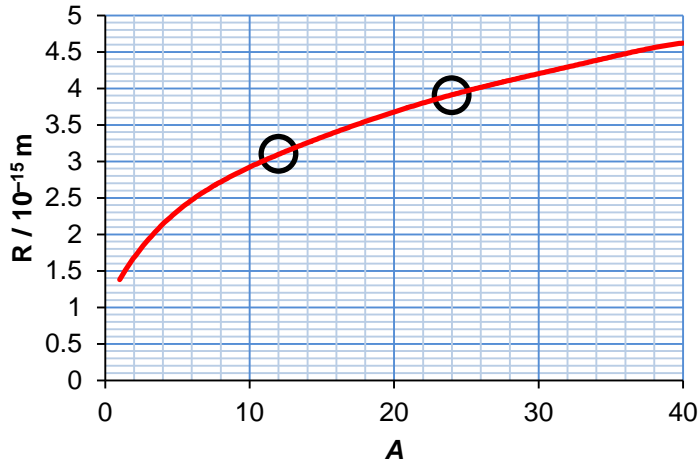

13 Data-based and practical questions (Section A)

- Curved line of best fit drawn going through the majority of the points.
 - $2.8 \times 10^{-12} \text{ m}^2$
 - 1.3 GN m^{-2} so yes
 - Area under curve from 20 mm to 50 mm \equiv 1 mJ
- Curved line of best fit drawn going through the majority of the points.
 - 8.3%
 - 3.32
 - 22.6
 - A graph of $\ln T$ against $\ln m$, gradient will be n

Option A Relativity

- 0.6c
 -

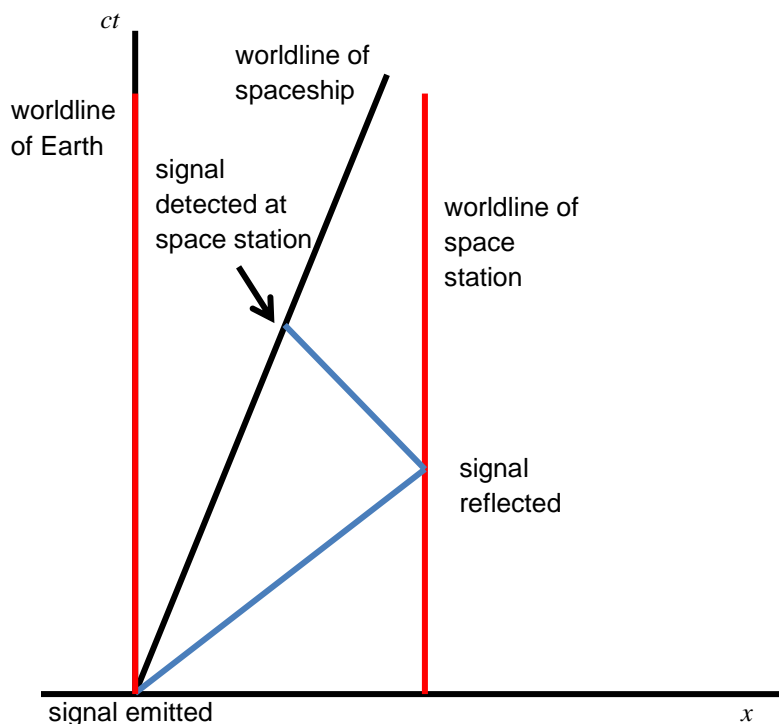

2. a) The length of an object measured in the rest frame of the object.
 b) $0.15 \mu\text{s}$
3. 15.2 GeV c^{-2}
4. a) Answer to 3 sf is $0.975c$.
 b) i) 0.18 m
 ii) 0.61 ns
 iii) 0.14 ns
 iv) 0.14 ns is the proper time interval because this is the interval measured in the electron frame.
5. a), b)

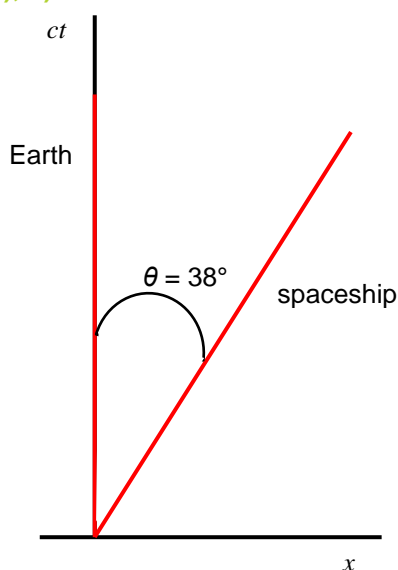

6. a) $0.97c$
 b) $2.77 \text{ GeV}; 2.77 \text{ GeV c}^{-1}$.

Option B Engineering physics

1. a) 4.3 rad s^{-1} b) 2 rad s^{-2} c) 6.0 N
2. The buoyancy force upwards is equal to the weight of displaced water; when the magnitude of the buoyancy force equals the weight of the wood, then it is in equilibrium; as wood is less dense than water the volume of the wood is greater than the volume of the water displaced and the wood floats with part of it above the surface
3. 5.3 kPa
4. a) 0.037 J
 b) Graph showing a single cycle, \sin^2 graph (always positive) ranging between 0 and 37 mJ in time of 4.0 s .
5. a) 2.03 rad s^{-2} b) 0.0712 N m c) 0.0303 kg
6. a) 0.027 mol

- b) i) T is now 334 k so not isothermal
- ii) The gas is compressed quickly, so there is no time for energy to transfer out or into the gas.
- c) +15 J as $\Delta Q = 0$
- d) This is an isothermal change and is reversible so the entropy change is equal and opposite to the entropy change of the surroundings.

Option C Imaging

1. a) See Figure C.1.2(b), page 183, of *IB Prepared Physics*. Image should be 4.8 cm from the mirror.
b) $m = 0.4x$ c) For on-axis rays there is no spherical aberration
2. a) The central diffraction maximum of one image is aligned with the first diffraction minimum position of the second image.
b) Resolution increases with aperture diameter; large mirrors are easier/cheaper to make than large lenses, because only one surface has to be ground.
3. 7.5×10^8 m apart
4. a) The output signal has a lower amplitude due to scattering in the fibre.
b) Modal dispersion has occurred—signals along the axis reach end of fibre quicker than those that are totally internally reflected many times in the fibre.
c) Repeated pulses are sent along the fibre separated by time $T = 1/f$, when two successive pulses overlap after pulse spreading then they cannot be distinguished so this places a lower limit on T and an upper limit on f .
5. a) $\frac{I_{30}}{I_{15}} = 116$
b) Low-energy X-radiation is absorbed by the patient and does not contribute to the final contrast; it increases the patient's radiation dose with no imaging advantages.
6. a) See Figure C.1.5(b), p 185 of *IB Prepared Physics*.
b) The image is virtual because the rays forming the image diverge, that is, they appear to have come from the image; virtual images cannot be formed on a screen.
c) The resolution of a lens depends on $\frac{\lambda}{\text{lens aperture}}$ so the smaller the wavelength for a fixed lens size, the smaller the minimum angle to resolve two images

Option D Astrophysics

- a) 10^{-3} m b) Isotropic, homogeneous c) 0.02 cm
- a) The age of the universe b) 0.58 mpc
- a) For collapse, the magnitude of the gravitational potential energy of a gas cloud must be greater than the kinetic energy of the gas cloud.
b) A hot diffuse cloud has large kinetic energy because the temperature is high but it has a low magnitude of gravitational potential energy as the cloud is diffuse.
- The capture of a neutron gives a nucleus of an isotope of iron that is unstable; this decays by beta decay to give an element heavier than iron.
- a) Cool, large volume and mass.
b) A group of stars seen from Earth with a distinctive shape; there is not necessarily a gravitational interaction between them
- a) 170 pc b) See page 203 of IB Prepared Physics. c) $27M_{\odot}$
d) Red giant, supernova, neutron star or black hole

IB Prepared Physics

Answers to practice exam papers

Here are the answers to the practice exam papers from *IB Prepared Physics*.

For direct access, click on the paper below.

Paper 1

Paper 2

Paper 3

Paper 1

- | | | |
|-------|-------|-------|
| 1. B | 15. D | 28. C |
| 2. A | 16. B | 29. B |
| 3. D | 17. C | 30. A |
| 4. C | 18. A | 31. C |
| 5. B | 19. B | 32. C |
| 6. B | 20. B | 33. B |
| 7. C | 21. D | 34. C |
| 8. C | 22. C | 35. A |
| 9. C | 23. C | 36. C |
| 10. A | 24. B | 37. D |
| 11. D | 25. A | 38. C |
| 12. B | 26. B | 39. A |
| 13. A | 27. A | 40. A |
| 14. D | | |

Paper 2

1. (a) The graph shows a decreasing acceleration.
 Force \propto acceleration and net force must be decreasing.
 Downwards weight is constant so upwards resistive force must be increasing.
- (b) When downwards force = upwards force, acceleration will be zero and speed will be constant.
- (c) The object reaches its terminal speed at 11 s. The distance travelled in this time is equal to the area under the graph up to 11s. The number of squares in this area should have been counted; the distance for one square should be given.
 This gives a distance = (200 ± 50) m

- (d) (i) Loss of gpe = $350 \times 15 = 5250$ (J)
 (ii) $E_K = \frac{1}{2} \times \left(\frac{15}{9.81}\right) \times 25^2 = 478$ (J)
 Difference = 4.77 (kJ)
 $4772 = 1.53 \times 330 \times \Delta T$
 $= 9.5$ (K)
 (iii) For example, no energy lost in heating / disturbing air.

- (e) Idea that all K_E transferred to crater formation.
 work done = force \times distance, so $F \times 0.12 = 478$ (J)
 $= 4.0$ kN

2. (a) Any **two** from:
- pattern does not move spatially with time / presence of fixed nodes
 - same phase between nodes
 - no net energy transfer
 - other suitable alternative.
- (b) (i) Pattern with three loops equal size by eye, node at each end.
 All four nodes labelled correctly.
- (ii) Any **three** from:
- reflection of original wave at end
 - waves superpose along string
 - some fixed positions where displacements of both waves are equal and opposite
 - at these positions / nodes waves sum to zero.
- (iii) Length of string is L
 For f_3 , $\lambda = \frac{2L}{3}$ and $f_3 = \frac{3c}{2L}$ and $f_4 = f_3 + 23 = \frac{2c}{L}$
 $23 = \frac{c}{1.8} (2 - 1.5)$
 83 m s^{-1}

3. (a) Graph for B is a straight line.
 Graph for A shows increasing resistance with pd.
- (b) (i) Energy per second transferred in A and B is same and charge flowing in each is same, so pd must be the same.
 Identifies intersection at (0.80, 4.0) as relevant point.
 emf of cell must equal the sum of the pd across A and B (as internal resistance is negligible).
 $= 8.0$ V
- (ii) For both A and B, $P = VI = 0.8 \times 4.0 = 3.2$ (W)
 total power transferred = 6.4 W

- (c) $V \propto I$ is the requirement for an ohmic conductor.
So, B is ohmic.
4. (a) Binding energy is the energy transferred *from* a nucleus when it is formed from its constituent particles.
- (b) (i) 3
(ii) Mass of Pu = 240.9791 u
mass difference = 1.926909 u
7.5 MeV / nucleon
- (c) Protons have positive charge and repel other protons through electrostatic force, so nucleus is inherently unstable.
Neutrons only susceptible to strong nuclear force which is attractive but weaker than repulsion at typical particle separations.
Balance (and stability) achieved when more neutrons than protons.
5. (a) Energy that can be released per unit mass.
- (b) Turbine has kinetic energy which is transferred to kinetic energy of dynamo.
Dynamo converts (rotational) kinetic energy to electrical energy (through interaction of magnetic field and electrons in dynamo coils).
Thermal energy is also transferred as wasted energy in electrical resistance / friction.
- (c) (i) Annual energy transfer = $3.5 \times 10^9 \times 365 \times 24 \times 3600$ (= 1.1×10^{17} J)
Mass of uranium = $E/c^2 = \frac{1.1 \times 10^{17}}{9 \times 10^{16}}$
= 1.23 kg
(ii) Angular speed = $60 \times 2\pi = 120\pi$ (rad s⁻¹)
Linear speed = $r\omega = 120\pi \times 1.4 = 530$ m s⁻¹
6. (a) Use of $\sin \theta = \frac{n\lambda}{d}$
 $\sin \theta = 0.9440$ or 0.9424 seen
Difference = 4.82 mrad / 0.276°
- (b) Use of $N = \frac{\lambda}{\Delta\lambda} \times \frac{1}{m}$
 $N = \frac{5.89 \times 10^{-7}}{1.00 \times 10^{-7}} \times \frac{1}{1}$
Six slits
- (c) Single slit gives rise to a diffraction pattern.
The wider this slit the narrower the central maximum of the diffraction pattern.
This central maximum defines the illuminated width of the diffraction grating.
The width is a maximum because any wider and less than six slits would be illuminated.

7. (a) Work done in taking unit positive charge from the point to infinity.
- (b) (i) $V = \frac{kq}{r} = (+) \frac{8.99 \times 10^9 \times 3.5 \times 10^{-6}}{2.5}$
 = 12.6 kV
- (ii) Kinetic energy of point charge is $\frac{1}{2} \times 0.23 \times 10^{-3} \times 1.8^2 = 0.3726$ mJ
 Potential difference between point charge position and surface of sphere = 57.4 kV
 Energy required to reach sphere = $57.4 \times 1000 \times 42 \times 10^{-9} = 2.41$ mJ
 Correct deduction from calculated values (the point charge will not reach the sphere).
8. (a) Any **three** from:
- the free electrons in the metal wings are being moved by the aircraft; each electron constitutes a current
 - an electric current in a magnetic field gives rise to a force / quotes $F = BIl$
 - this force acts on the free electrons and drives them all in the direction of one wing tip / consistent use of direction rule to show force direction
 - the movement of the electrons is equivalent to the generation of an emf.
- (b) The rate at which the aircraft wing is cutting the (vertical component of) magnetic field lines.
- (c) Use of $\varepsilon = Bvl$
 5.7 V
- (d) States Lenz's law.
 The induced emf, when it gives rise to a current, will produce a force on the aircraft acting in the opposite direction to its direction of motion.
 However, when the electron separation has occurred, the current is zero and there is no opposing force.
9. (a) The wave theory predicts that:
- all waves transfer energy whatever their wavelength
 - even if incident power is small, eventually, enough energy should accumulate to emit electron
- (this is not observed for long wavelengths).
- (b) (i) Energy of photon = 3.2×10^{-19} (J)
 Threshold frequency = $\frac{E}{h} = 4.8 \times 10^{14}$ Hz
- (ii) Use of $E = h(f - f_0)$ or equivalent
 $f - f_0 = 2.32 \times 10^{14}$ Hz
 $E = 1.54 \times 10^{-19}$
 = 0.963 eV
- (c) A new theory that produces a fundamental change in the way that scientists think about an aspect of their subject.

Paper 3

SECTION A

1. (a) Reading 1.30 MPa and absolute uncertainty 0.40 MPa
 $\frac{0.40}{1.30} \times 100 = 31\%$

- (b) Recognition that $p \times V$ should be constant.
 Obtains table as follows.

V / cm^3	p / MPa	$P \times V$
10	1.30	13
15	1.08	16.2
25	0.76	19
30	0.64	19.2
35	0.54	18.9
40	0.46	18.4

Concludes that relationship is probably true for $V > 25 \text{ cm}^3$

- (c) (i) Between 0.88 and 0.95
 (ii) Between 1.50 and 1.60
- (d) (i) Is more reliable as it is an interpolation between two close numbers.
 (ii) Is outside the range of data and there may be a significant change in behaviour.
2. (a) Mean = 50.0 cm
 Absolute uncertainty = 0.6 cm
- (b) Area = $50.0 \times 75.1 = 3755 \text{ cm}^2$
 Fractional uncertainty = $\frac{0.6}{50} + \frac{0.4}{75.1} = 0.0173$
 So, absolute uncertainty = $0.0173 \times 3755 = 65 \text{ cm}^2$ (3760 ± 70) cm^2
- (c) For example, wood worn from zero end so readings are all too high.

SECTION B

3. (a) A set of axes that are stationary relative to a given observer or object.
- (b) Protons in the wire are moving in electron frame.
 So the proton separations are contracted relative to the electrons in wire.
 There is a net force of attraction between free electron and wire (as before).
 Observer moving with free electron describes this as electrostatic.

4. (a)
$$\gamma = \frac{1}{\sqrt{1 - \frac{v^2}{c^2}}} = \frac{1}{\sqrt{1 - 0.85^2}} = 1.89$$

$$L = \frac{L_0}{\gamma} = \frac{650}{1.89} = 342 \text{ m}$$

(b)
$$u' = \frac{u + v}{1 + \frac{uv}{c^2}} = \frac{0.85c - 0.20c}{1 - \frac{0.85 \times 0.20c^2}{c^2}} = 0.78c$$

5. (a)
$$\gamma = \frac{1}{\sqrt{1 - \frac{v^2}{c^2}}} = \frac{1}{\sqrt{1 - 0.98^2}} = 5.02$$

$$= 180 \text{ ns}$$

(b) The pion travels a proper length (of 10.8 m) in its own frame before it decays. To the stationary observer, this length is shorter / contracted to about 2 m. This appears to be less than the proper time / than only approximately 7 ns, well within the decay time.

6. (a) (i) 1.8 years
 (ii)
$$\gamma = \frac{1}{\sqrt{1 - \frac{v^2}{c^2}}} = \frac{1}{\sqrt{1 - 0.6^2}} = 1.25$$

$$= 1.44 \text{ years}$$

(b) $\tan \alpha = 0.6$, $\alpha = 31^\circ$
 Jill world line shown.
 Jack world line shown.

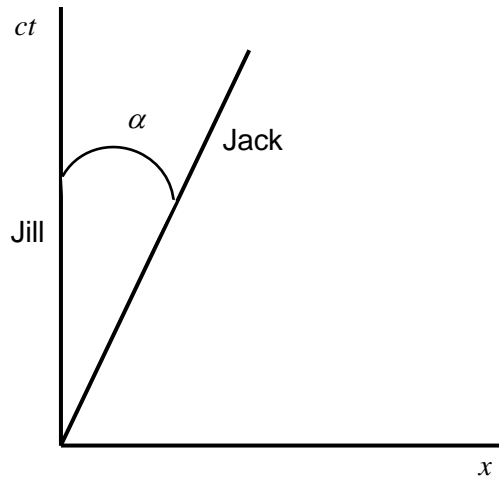

7. (a)
$$2 = (\gamma - 1)m_0c^2 = (\gamma - 1) \times 0.511$$

$$\gamma - 1 = \frac{2}{0.511}$$

$$\gamma = 1 + \frac{2}{0.511} = \frac{2.511}{0.511} = 4.9$$

$$= 0.978c$$

(b) (i) Initial energy = $2 + 2 + 2 \times 0.511 = 5.02 \text{ MeV}$ shared between two photons.
 (ii) $E = pc$ so 2.51 MeV c^{-1}

8. (a) Gravity is the warping of spacetime.
 The ball takes the shortest distance in spacetime.
 The ball trajectory is curved because this is the shortest distance after the warp.

(b) Recognition that this radius is the Schwarzschild radius.

$$R_s = \frac{2GM}{c^2} = 8.9 \text{ mm}$$

9 (a) Initial angular speed = $\frac{2\pi}{18} \text{ rad s}^{-1}$
 Use of $t = \frac{2\theta}{\omega_f + \omega_i}$
 108 s

(b) $\alpha = \frac{2\pi}{18} \times \frac{1}{108} = 3.2 \text{ mrad s}^{-2}$
 Use of $\Gamma = I\alpha$
 25.9 N m

10. Any **three** from:
- The hollow cylinder has the greater moment of inertia because more mass is distributed further from the rotation axis.
 - The gravitational potential energy is transferred into the total kinetic energy of both cylinders; this consists of a rotational kinetic energy and a translational kinetic energy.
 - More energy is transferred to the rotational form for the hollow cylinder, so less is available (over the whole ramp) for translational kinetic energy.
 - The hollow cylinder reaches the end of the ramp after the solid cylinder.

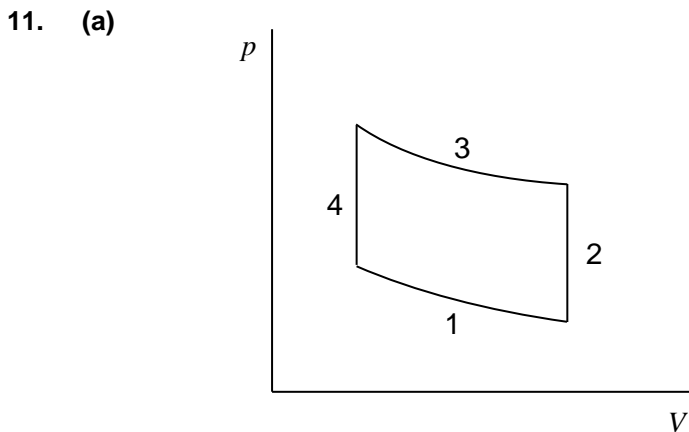

1 and 2 drawn correctly.
 3 and 4 drawn correctly.

- (b) (i) Calculates $pV^{5/3}$ for both values.
 0.48 shown.
 Same value, so must be adiabatic.
 (ii) Uses $n = pV/RT$; 0.98(2) mol
 (iii) 221 K
 (iv) As $\Delta Q = 0$ the change in internal energy of the gas must be equal to the work done on the surroundings / the atmosphere.

12. (a) Work to establish that $\frac{x}{0.25} = \frac{\rho_{\text{wood}}}{\rho_{\text{water}}} = \frac{160}{1030} = 0.16$

(b) Volume is constant but mass increases.
 Fraction under water will increase.

13. (a) Amplitude of pendulum will decrease.
 Stopping after about 150 oscillations.
 Losing about 4% of the energy each cycle.

- (b) Frequency of pendulum = 1.27 Hz
 When $f = 1.2$ Hz, close to but below resonance so amplitude large and phase difference just under $\pi/2$
 When $f = 3.0$ Hz, amplitude smaller than before and phase difference π .

14. (a)

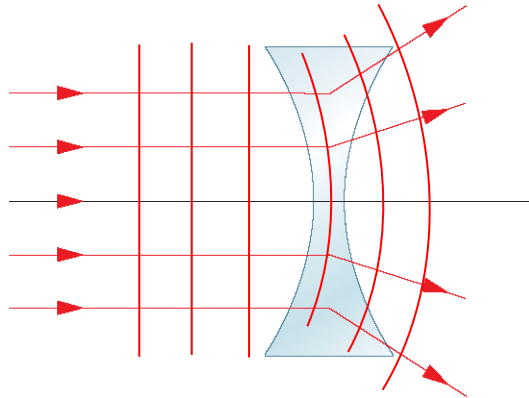

Wavefronts curve outwards inside and beyond lens.

- (b) Any **two** from:
 After leaving the lens, the wavefronts appear to have come from a point. This point is the location of the image. The image is virtual because it cannot be formed on a screen.
 (c) Rays appear to have come from point 6 cm to left of the diverging lens. This point must act as the focal point of the converging lens. If x is distance between lenses, $6 + x = 18$, $x = 12$ cm

15. (a) Enlarged inverted virtual image (formed at near point of eye).

(b) Image formed by eyepiece lens:

$$\frac{1}{u} + \frac{1}{-250} = \frac{1}{90}$$

$$u = 66.2 \text{ mm}$$

So, image formed by objective is $240 - 66.2 = 173.8$ mm from objective.

$$\frac{1}{u} + \frac{1}{173.8} = \frac{1}{30}$$

$$u = 36.3 \text{ mm}$$

16. (a) $n_{\text{core}} n_{\text{cladding}} = 1.13$

$$c = \sin^{-1}\left(\frac{1}{n}\right) = 62^\circ$$

(b) Refracted angle at entrance to core = $90 - 62 = 28^\circ$

$$\frac{\sin \theta}{\sin 28^\circ} = 1.56$$

$$\theta = 47^\circ$$

(c) Attenuation = $5.7 \times 1.24 = 7.06$ dB

$$\text{Use of attenuation in dB} = 10 \log_{10}\left(\frac{I}{I_0}\right)$$

$$2.95 \text{ mW}$$

17. (a) 2.2 km

(b) $\mu = \frac{\ln 2}{2200} = 3.21 \times 10^{-4}$
 $e^{-\mu x} = 0.00033$

(c) Only 0.03% of the X-rays reach the ground so this gives some protection to life on Earth.

18. (a) Protons flipped into parallel anti-parallel spin states by uniform magnetic field. As protons relax, rf signal is emitted. Knowledge of field strength gives information of location and density of protons (hydrogen/water).

(b) Gradient field added to uniform magnetic field. Frequency emitted in relaxation depends on total strength. Variation of total field with position known accurately, so density of protons also known.

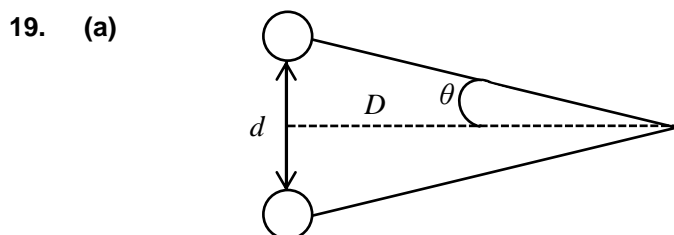

(b) metre and radian

20. (a) $d = \frac{1}{p} = \frac{1}{3.4 \times 10^{-3}} = 294 \text{ pc}$

(b) $L = \sigma AT^4 = 5.67 \times 10^{-8} \times 9.68 \times 10^{10} \times 42400^4$
 $1.8 \times 10^{22} \text{ W m}^{-2}$

(c) 54 nm

21. (a) $\frac{L_1}{L_2} = \left(\frac{M_1}{M_2}\right)^{3.5} = 370 \therefore \frac{M_1}{M_2} = 5.4$
 Mass of X = $1.1 \times 10^{31} \text{ kg}$

(b) (i) X is likely to form a planetary nebula leading to a white dwarf. Y is likely to undergo a supernova leading to a neutron star or black hole.
 (ii) These could be the same if the mass of X as a white dwarf is greater than the Chandrasekhar limit. This limit is about 1.4 times mass of Sun.

22. (a) $\frac{L}{T^4} \propto A$ seen.
 So, $\frac{A_C}{A_\odot} = \frac{L_C}{L_\odot} \times \left(\frac{T_\odot}{T_C}\right)^4 = 80 \times 1.14^4$
 Surface area of Capella is 135x that of Sun.

Luminosity of Capella = $3.0 \times 10^{28} \text{ W m}^{-2}$

(b) $r = \sqrt{\frac{L}{4\pi\sigma T^4}}$
 $= 8.3 \times 10^9$

(c) $d = \sqrt{\frac{L}{4\pi b}} = \sqrt{\frac{40 \times 3.8 \times 10^{26}}{4\pi \times 2.2 \times 10^8}} = 2.34 \times 10^{17} \text{ (m)} = 7.6 \text{ pc}$

23. (a) The upper value on the mass (~ 3 solar masses) of a neutron star for which it cannot collapse to a black hole.
- (b) (i) Blue star on main sequence \rightarrow red *supergiant*.
 (ii) \rightarrow helium burning super giant \rightarrow supernova \rightarrow neutron star.
- (c) Black hole – it exceeds the Oppenheimer–Volkoff limit.

24. (a)

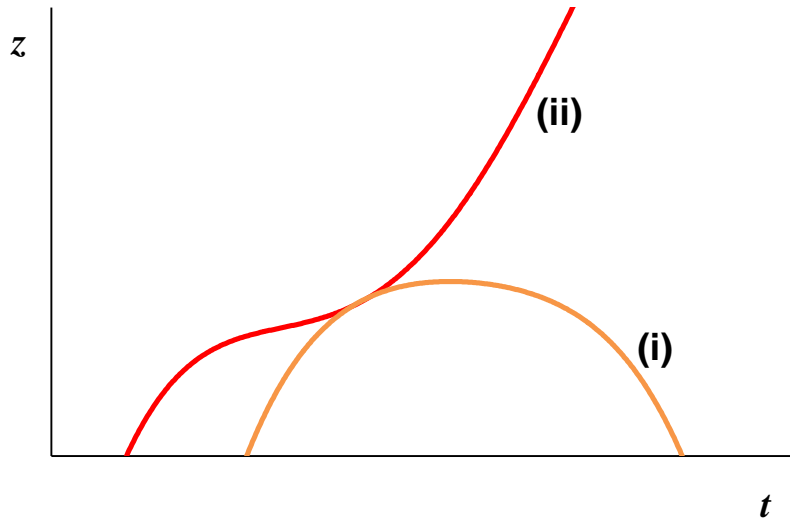

- (i) Shape of curve closed, semicircle.
 (ii) Shape of curve open, upwards.
 Curves touch at present time.
- (b) So, knowing brightness of supernova (at Earth) gives distance to supernova. Universe is thought to be expanding faster than expected. This matches theories of expansion of universe in presence of dark energy.